

SPICE thermal model

BUK653R5-55C

Symbol	Parameter	Conditions	Min	Typ	Max	Unit
$R_{th(j-mb)}$	thermal resistance from junction to mounting base		-	-	0.57	K/W

C_{th1}	5.200E-02 F
C_{th2}	1.200E-02 F
C_{th3}	3.612E-03 F
C_{th4}	1.105E-03 F
C_{th5}	3.380E-04 F
C_{th6}	1.034E-04 F
C_{th7}	3.164E-05 F
C_{th8}	9.678E-06 F
R_{th1}	4.200E-01 Ω
R_{th2}	1.190E-01 Ω
R_{th3}	2.500E-02 Ω
R_{th4}	5.169E-03 Ω
R_{th5}	1.078E-03 Ω
R_{th6}	2.248E-04 Ω
R_{th7}	4.687E-05 Ω
R_{th8}	9.775E-06 Ω

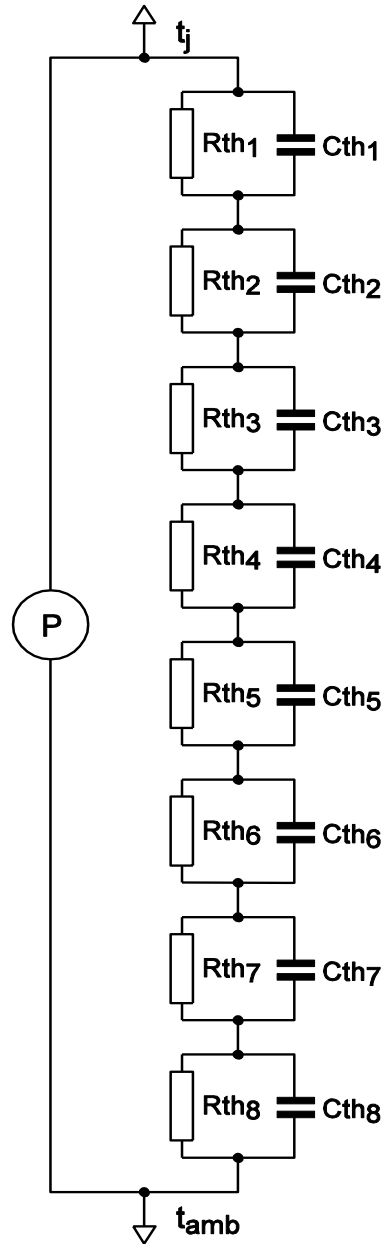

001aal768

Part: BUK653R5-55C
 Version: 1
 Date: 7-7-2010
 Rth: 0.570435212